

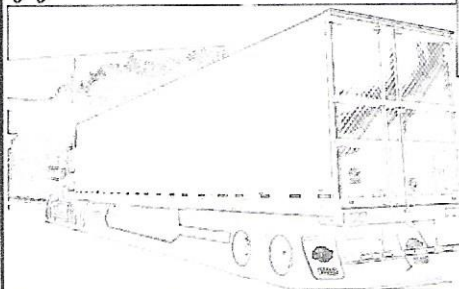

# CTM 24166 US TRAILER - LIGHTS







CTM PHOTOETCHED AND RESIN PARTS

**CAUTION  
WIDE  
TURNS**



DEDICATED SET FOR  
US TRAILERS:  
- TAIL LIGHTS  
- MARKER LIGHTS  
- REFLECTORS  
- WIDE TURNS SIGNAL

CTM 24166 US TRAILER - LIGHTS

-  - DETACH WITH KNIFE
-  - BEND
-  - REPLACEMENT PART
-  - OPTIONAL
-  - REPEAT
-  - DRILL HOLE
-  - GRIND

*This set is not a children's toy and was designed for professional modellers only who already have some skills in working with photoetched parts. Special tools for bending of photoetched parts is recommended when working with this set. Non using this tool during bending may cause destruction of the part. Careful bending of the most of the parts could be also done using a metal ruler, a sharp knife and a tweezers on a hard surface. Pay attention, be careful and keep your safety and health in mind during work!*

*For gluing and filling a cyanoacrylate glue and a glue removing liquid is recommended. When (or even before) working with each part inspection of the real part on the vehicle or a picture of the real thing is recommended and helpful.*

*Modification of plastic parts may be required for proper use of some of the photoetched parts*

CTM 24166 US trailer - lights

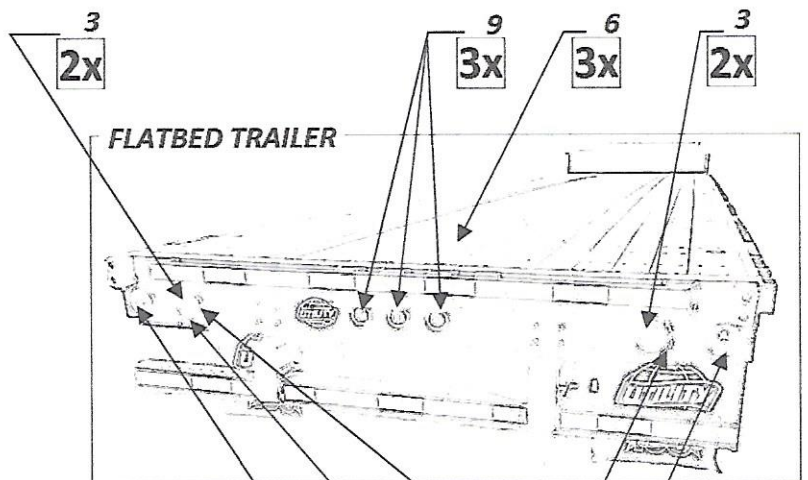
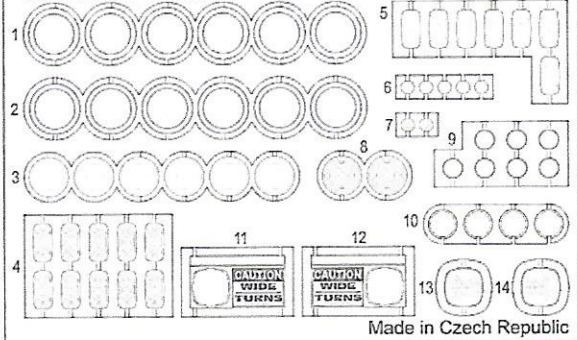

11, 12  
2x  ?

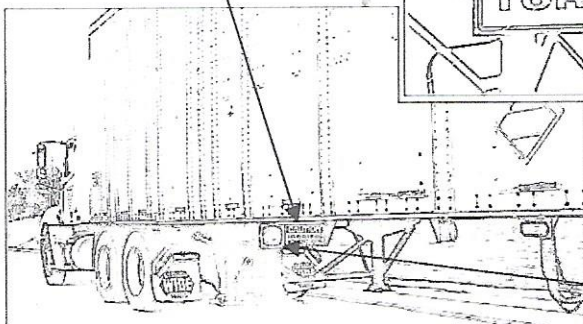

13, 14  
2x ?

1 2  
2x 2x

3 8  
2x ? 2x

**REEFER TRAILER**

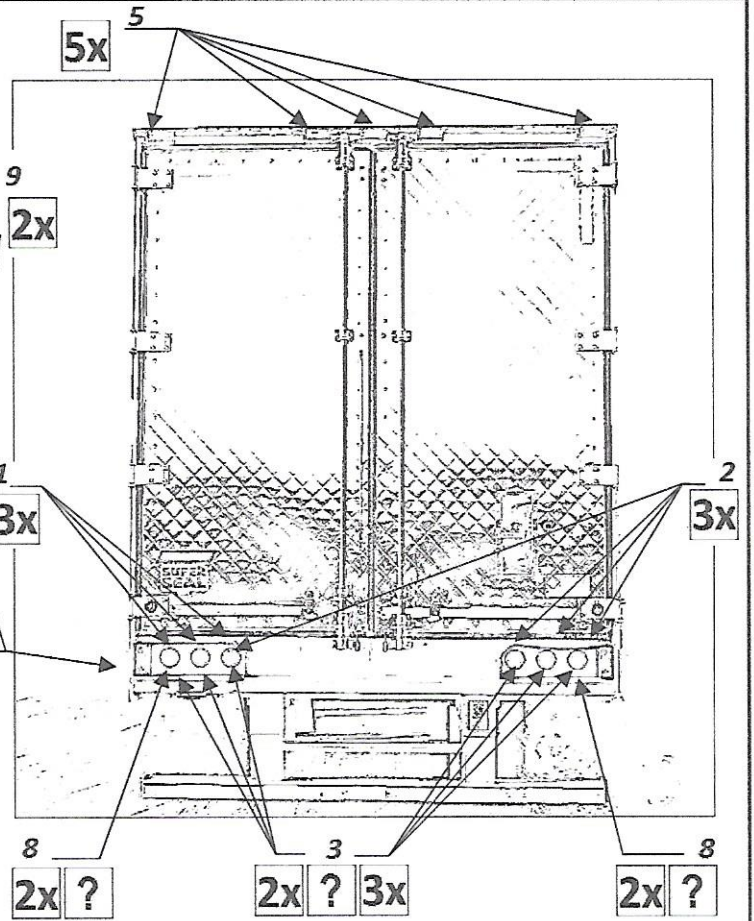
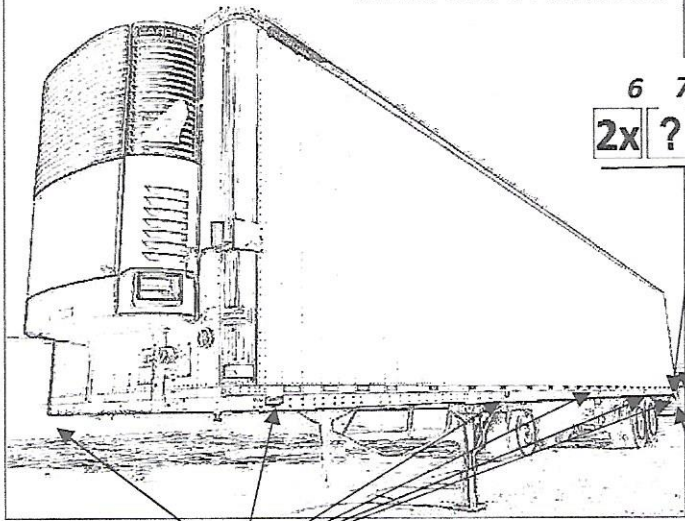

**TANK TRAILERS**

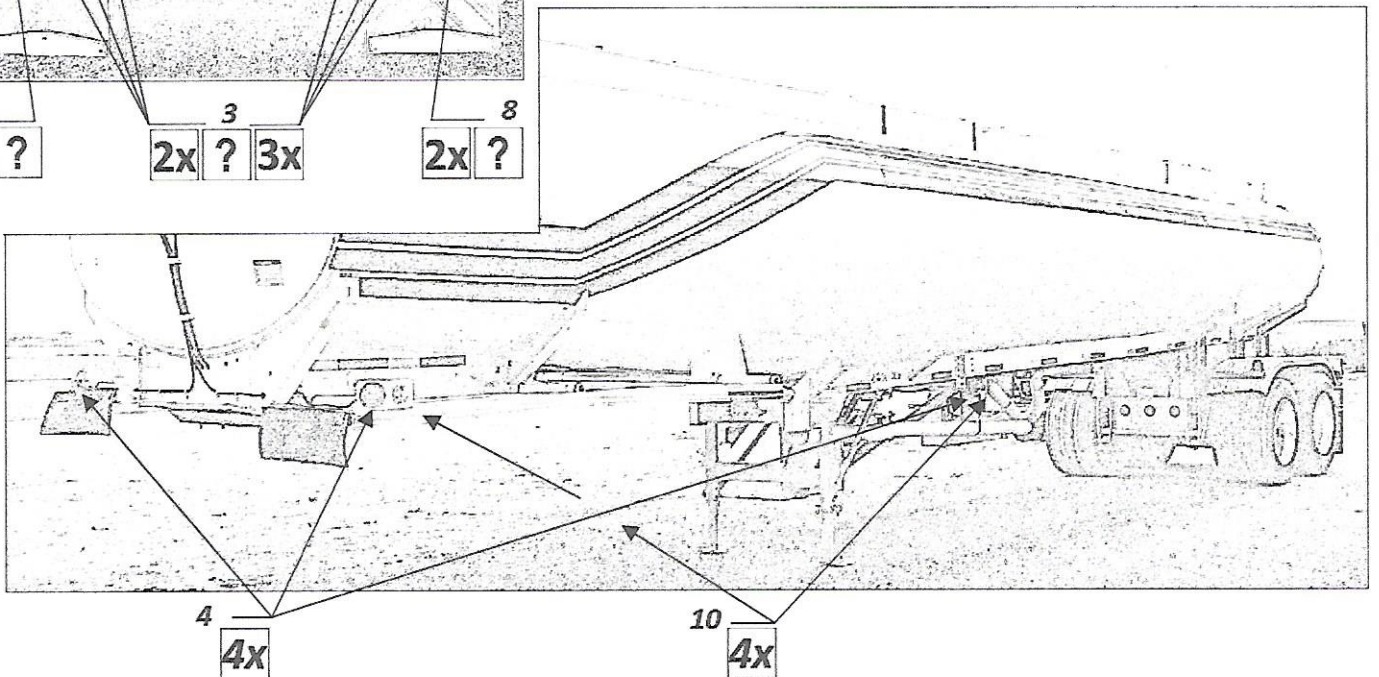
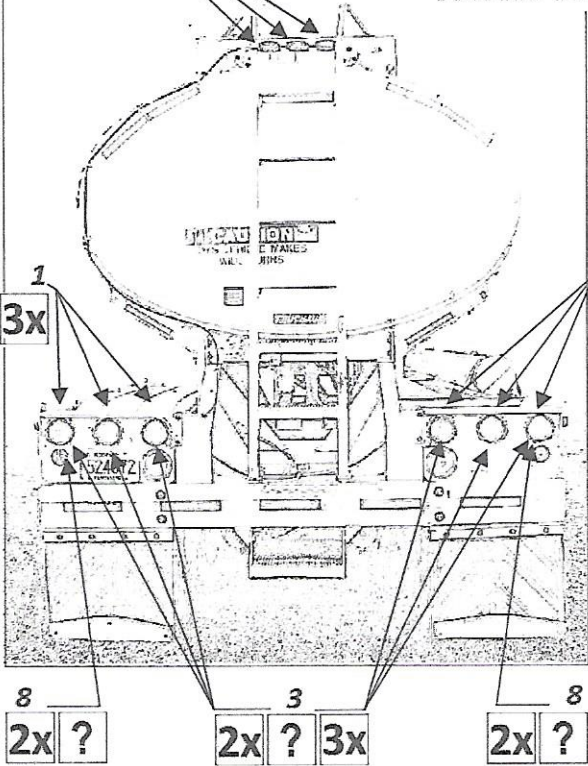

6 7 9  
2x ? 2x

5x

1 3x

2 3x

4 10x

5 3x

8 2x ?

3 2x ? 3x

8 2x ?

1 3x

2 3x

8 2x ?

3 2x ? 3x

8 2x ?

4 4x

10 4x